

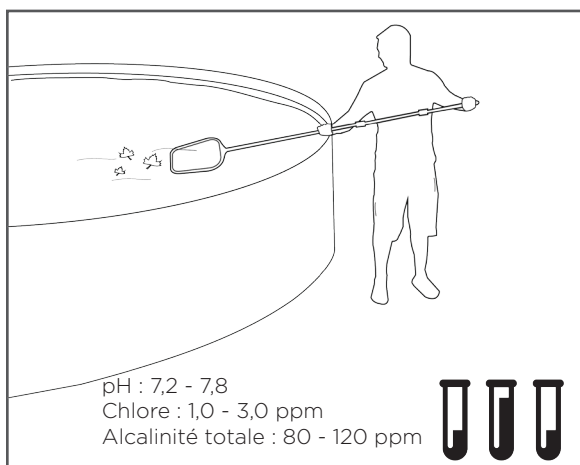

Nettoyeur automatique à aspiration pour piscines hors-sol
Manuel de démarrage rapide

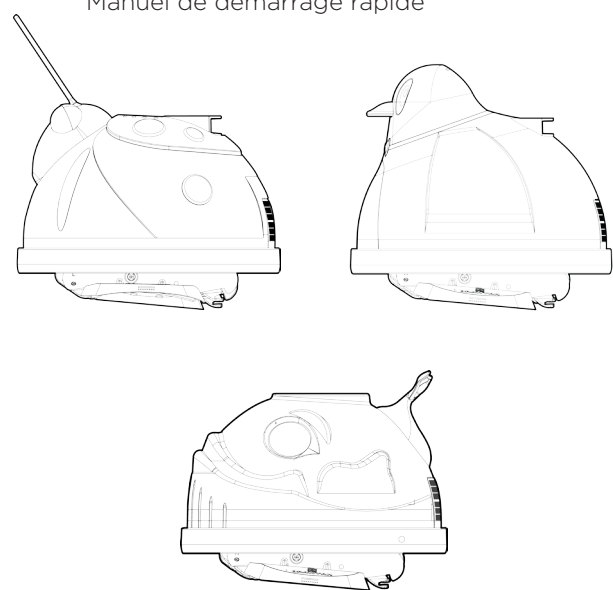

1 Retirer les débris/vérifier les produits chimiques pour la piscine

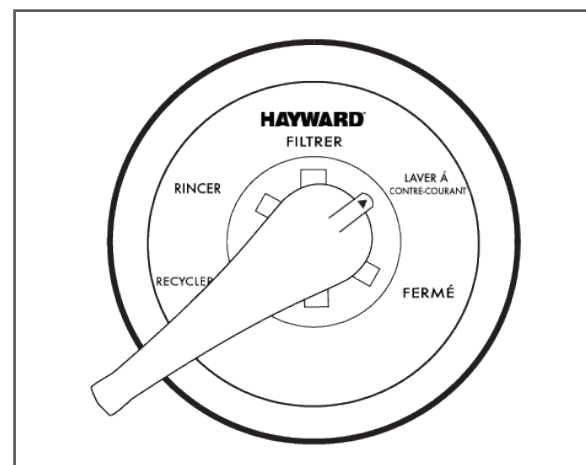

2 Nettoyer le filtre

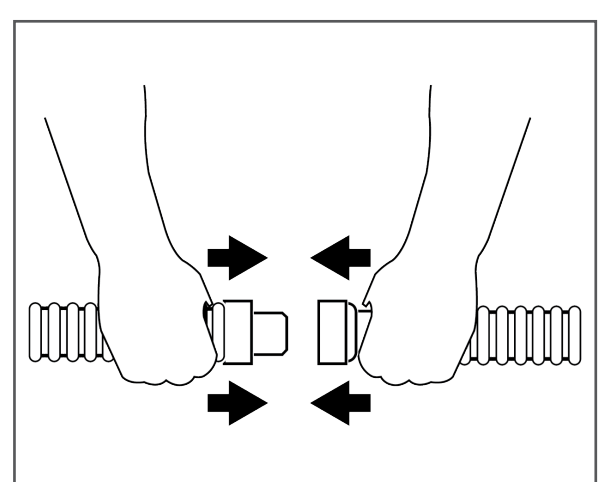

3 Raccorder les sections de tuyau

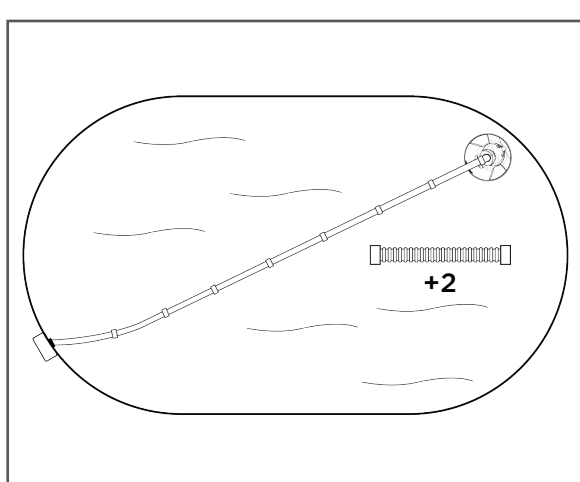

3B Déterminer la longueur du tuyau

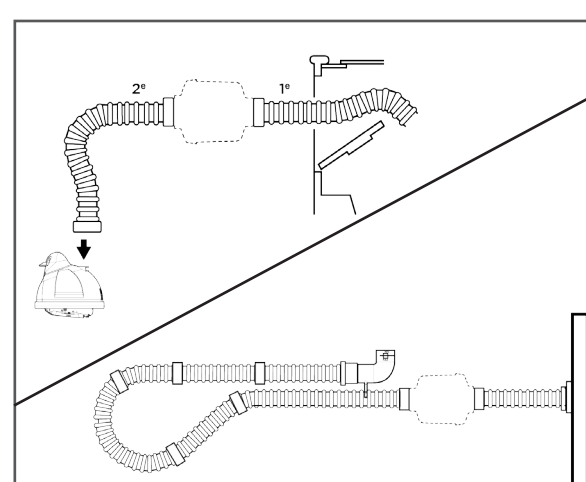

4 Installer dans l'écumoire



Suite du recto

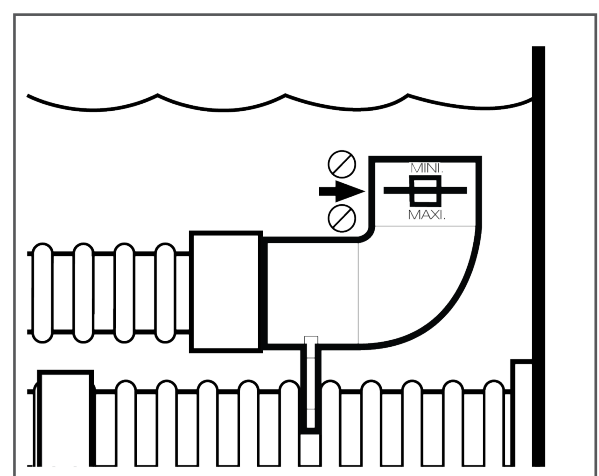

5 Vérifier l'indicateur de débit puis le régler tel que recommandé

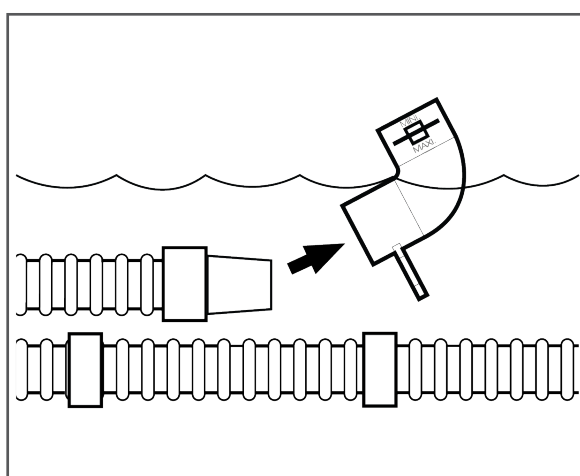

6 Retirer l'indicateur de débit

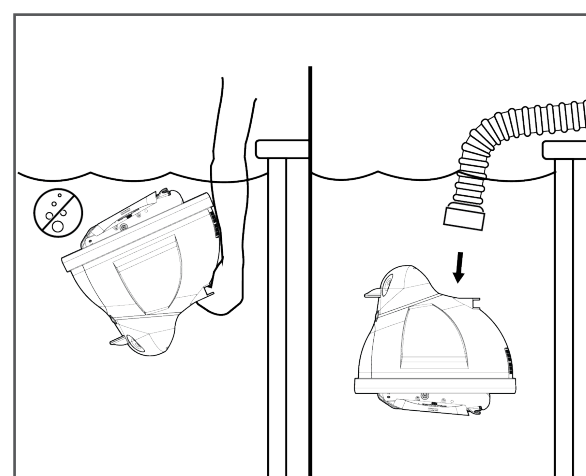

7 Raccorder le nettoyeur au tuyau

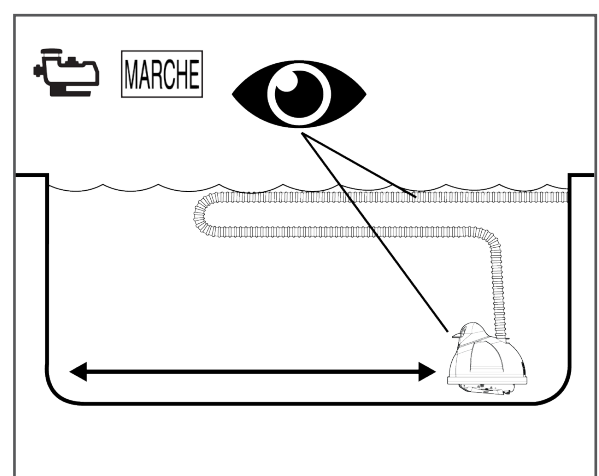

8 Mettre la pompe en marche

Hayward Pool Products
620 Division Street, Elizabeth, NJ 07201 USA
908.351.5400 • www.hayward.com



ABOVE GROUND SERIES
Suction Pool Cleaner
Quick Start Guide

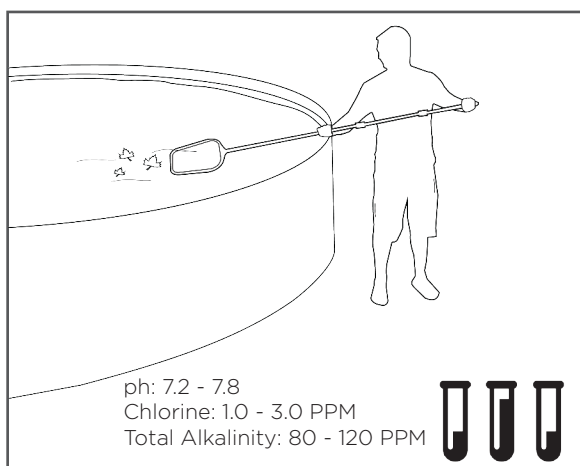
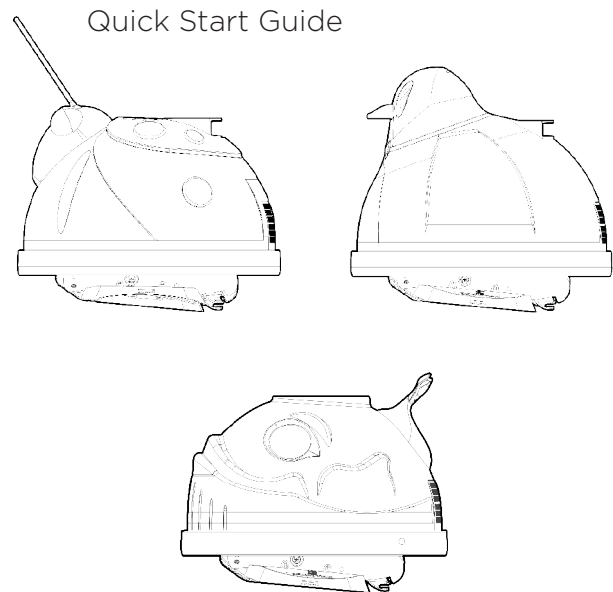

1 Clear Debris / Check Pool Chemicals

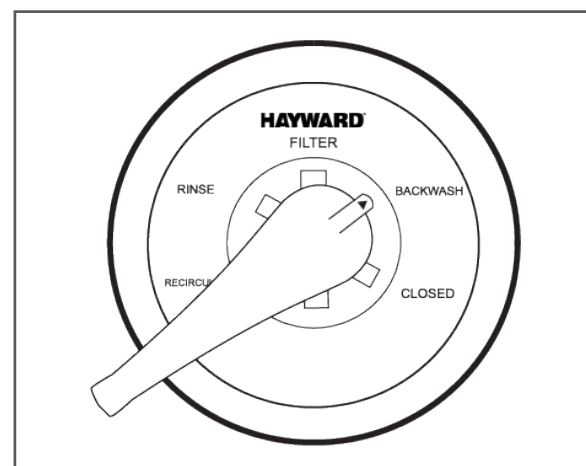

2 Clean Filter

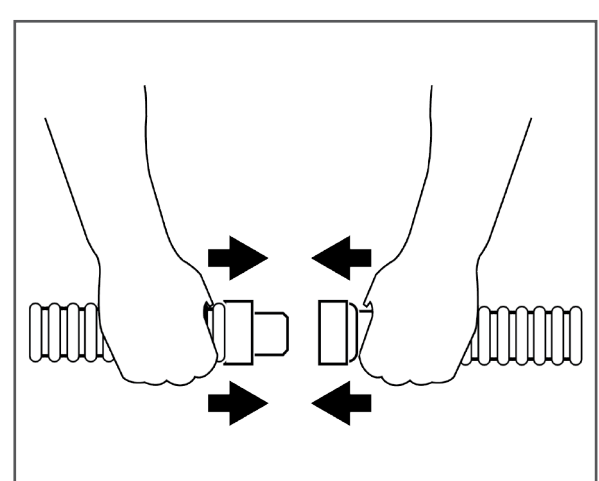

3 Connect Hose Sections

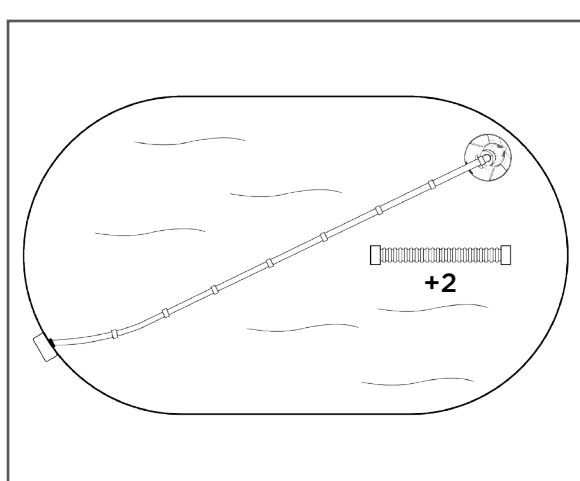

3B Determine Hose Length

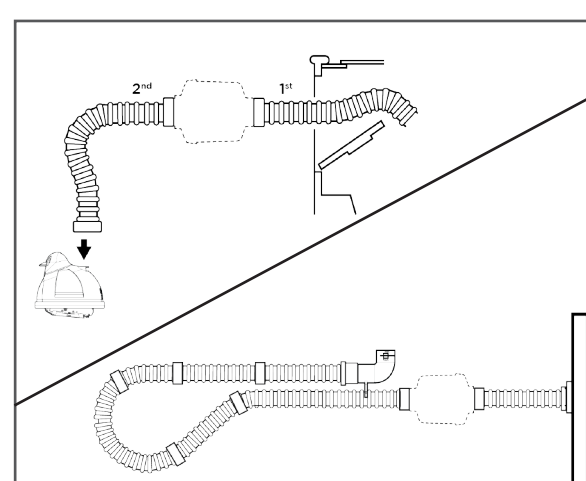

4 Install in Skimmer / Hayward Vac Lock®



Continued From Front

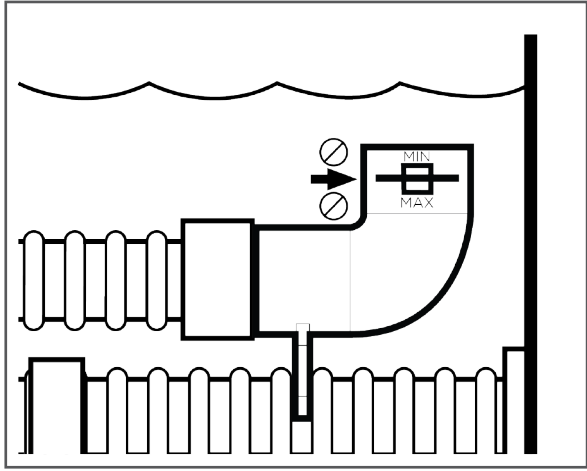

5 Inspect Flow Gauge and Adjust as Required

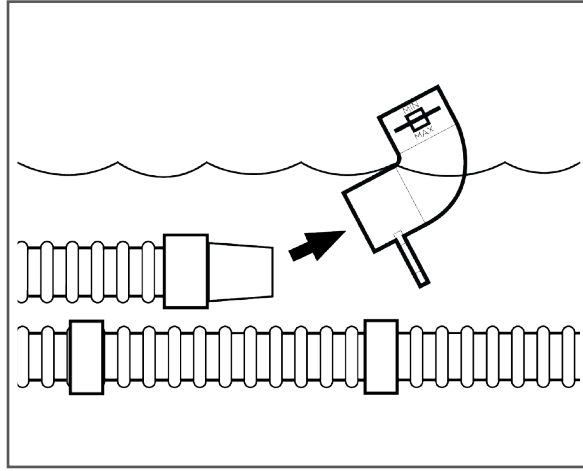

6 Remove Flow Gauge

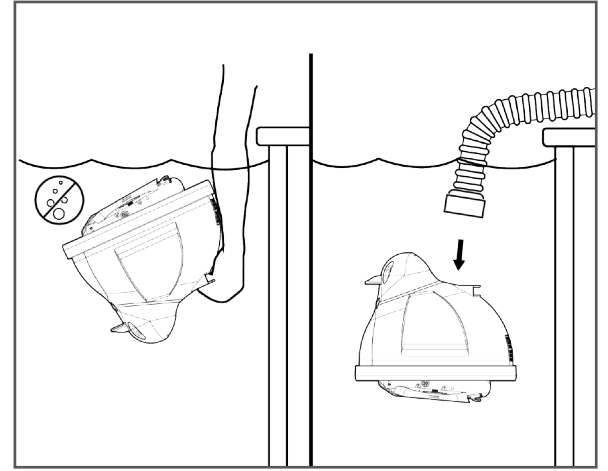

7 Connect Hose Cuff

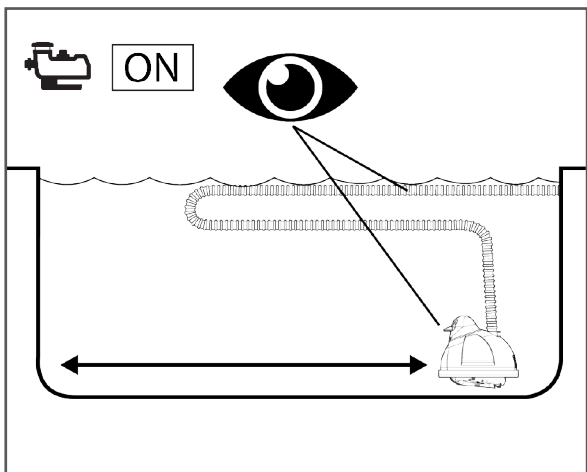

8 Turn Pump On

Hayward Pool Products
620 Division Street, Elizabeth, NJ 07201 USA
908.351.5400 • www.hayward.com



SERIE POR ENCIMA DELSUELO
Aspiradora de Alberca
Guía Rápida

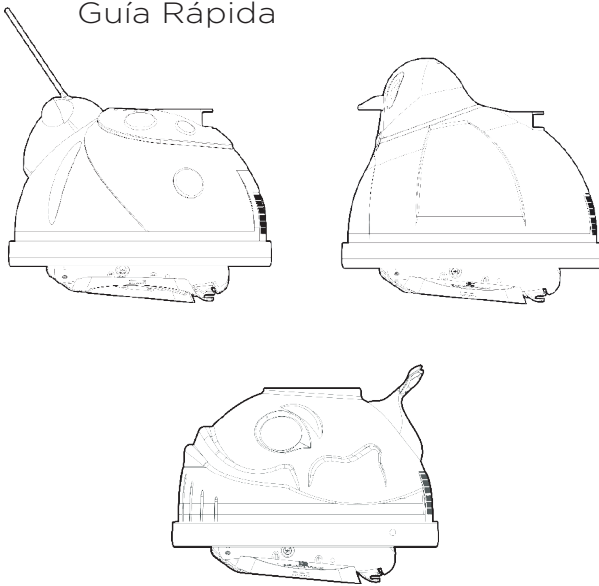

QRG926 Rev. A

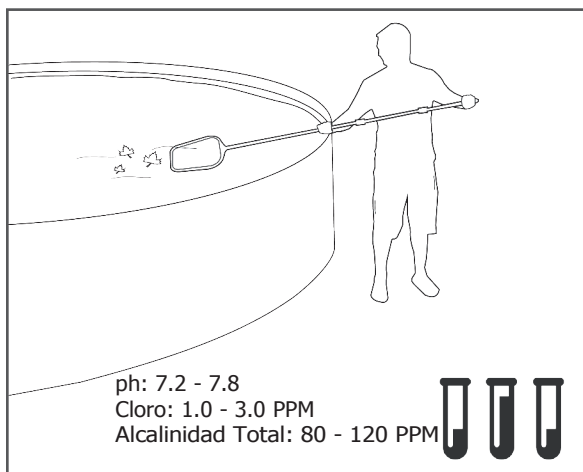

1 Retire Basura /
Cheque químicos de alberca

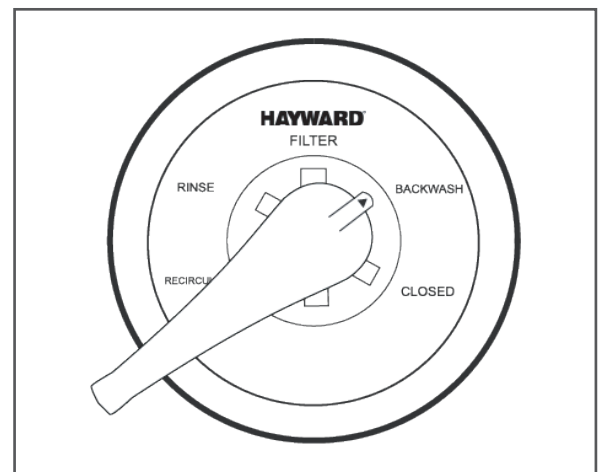

2 Limpie Filtro

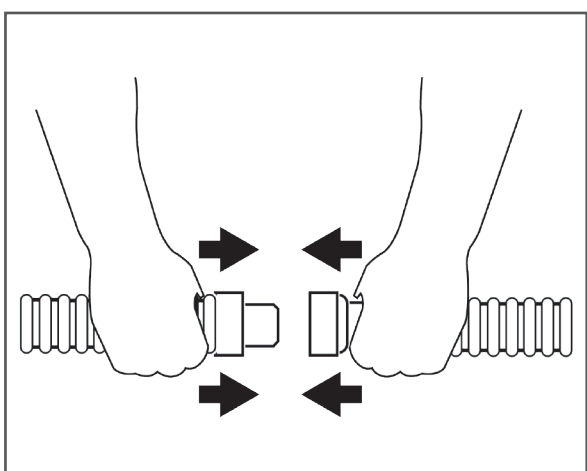

3 Conecte las secciones de manguera

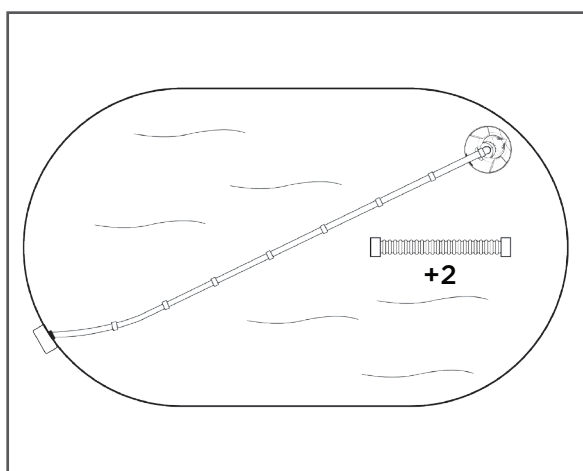

3B Determine el largo de la manguera

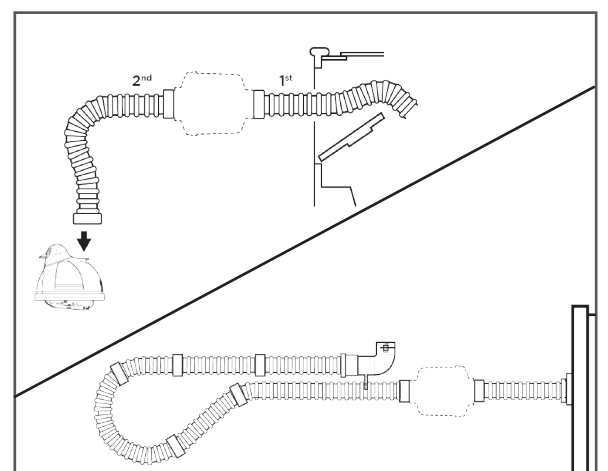

4 Instale el colador / Hayward Vac Lock®



Continuación

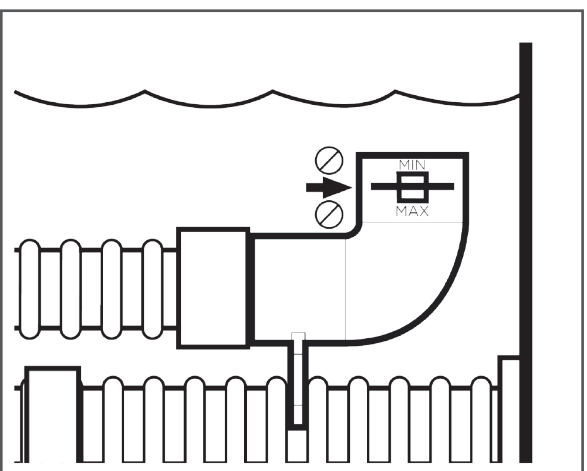

5 Inspeccione el medidor de flujo y ajuste si se requiere

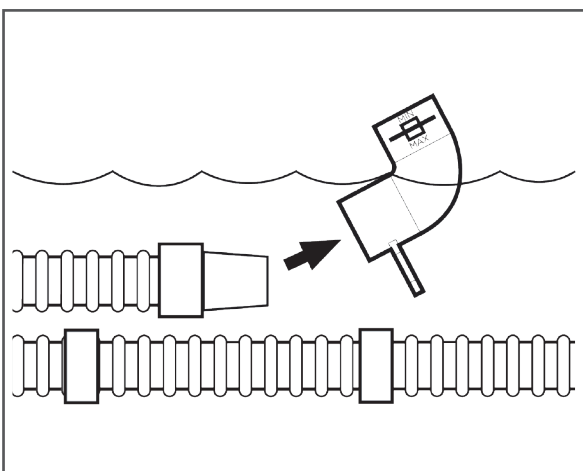

6 Quite el medidor de flujo

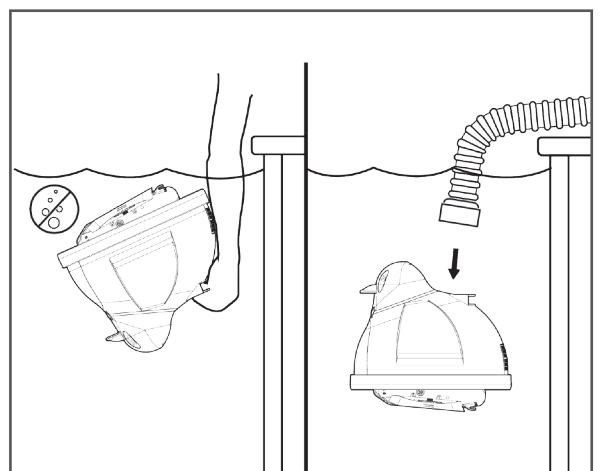

7 Conecte la manguera

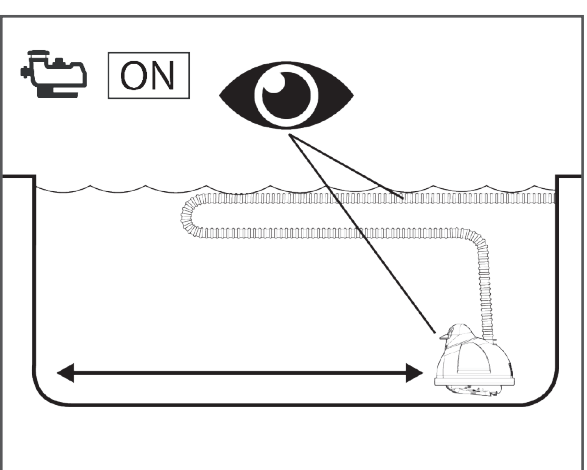

8 Prenda la Bomba

Hayward Pool Products
620 Division Street, Elizabeth, NJ 07201 USA
908.351.5400 • www.hayward.com